

Wireless Professional Weather Center

Instructions Manual

TABLE OF CONTENTS

TABLE OF CONTENTS	34
INTRODUCTION.....	37
INVENTORY OF CONTENTS.....	37
FEATURES:	38
WIRELESS DISPLAY	38
THERMO-HYGRO SENSOR	38
WIND SENSOR	38
RAIN SENSOR	39
SETTING UP:	39
ADDITIONAL NOTES FOR THE SOLAR WIND AND RAIN SENSORS MODES	40
MOUNTING THE SENSORS AND PLACEMENT OF THE WIRELESS DISPLAY:	41
WIND SENSOR	42
RAIN SENSOR	42
THERMO-HYGRO SENSOR	42
HEAVY WEATHER PC SOFTWARE.....	42
FUNCTION KEYS:	43
SET KEY.....	43
▲UP ARROW KEY.....	43
▼DOWN ARROW KEY	43
ALARM KEY	43
MIN/MAX KEY	43
LCD SCREEN	44
MODE 1 DISPLAY:.....	44
MODE 2 DISPLAY:.....	44
MANUAL settings:	45
LCD CONTRAST SETTING.....	45
MANUAL TIME SETTING:.....	45
12/24 HOUR TIME DISPLAY SETTING:	46

CALENDAR SETTING:	46
°F/°C TEMPERATURE UNIT SETTING	47
WIND SPEED UNIT SETTING	47
RAINFALL UNIT SETTING	48
RELATIVE AIR PRESSURE UNIT SETTING	48
RELATIVE PRESSURE REFERENCE VALUE SETTING	49
WEATHER TENDENCY SENSITIVITY LEVEL SETTING	49
STORM WARNING THRESHOLD VALUE SETTING.....	50
STORM ALARM ON/ OFF SETTING.....	50
WIND DIRECTION DISPLAY TYPE SETTING	50
FACTORY RESET PROCEDURE	51
TO EXIT THE MANUAL SETTING MODE.....	52
WEATHER ALARM OPERATIONS	52
THE FOLLOWING WEATHER ALARMS CAN BE ADDJUSTED IN ALARM SETTING MODE	52
DEFAULT WEATHER ALARM VALUES:	53
PRESSURE ALARMS.....	53
INDOOR TEMPERATURE ALARMS	54
INDOOR HUMIDITY ALARMS.....	54
OUTDOOR TEMPERATURE ALARMS	55
OUTDOOR HUMIDITY ALARMS.....	55
WIND GUST ALARM	56
WIND DIRECTION ALARM	56
24H RAINFALL ALARM	57
HYSTERESIS	58
WEATHER FORECAST AND WEATHER TENDENCY	58
WEATHER FORECASTING ICONS:.....	58
WEATHER TENDENCY INDICATOR.....	59
AIR PRESSURE HISTORY (ELECTRONIC BAROMETER WITH BAROMETRIC PRESSURE TREND)	59
WIND DIRECTION AND WIND SPEED MEASUREMENT	60
RAINFALL MEASUREMENT	61

VIEWING THE MIN/MAX WEATHER DATA	61
RESET THE MINIMUM AND MAXIMUM WEATHER DATA.....	61
TOTAL RAINFALL AMOUNT	61
CARE AND MAINTENANCE:.....	62
SPECIFICATIONS:.....	62
INDOOR TEMPERATURE.....	62
OUTDOOR TEMPERATURE / DEW POINT	62
INDOOR HUMIDITY	62
OUTDOOR HUMIDITY	62
WIND SPEED/ GUST	62
WIND CHILL/ DEW POINT	63
RAINFALL (24H ; TOTAL)	63
OUTDOOR DATA RECEPTION	63
AIR PRESSURE	63
TRANSMISSION RANGE	63
POWER CONSUMPTION.....	63
DIMENSIONS (L X W X H).....	63
LIABILITY DISCLAIMER.....	63

INTRODUCTION

Congratulations on purchasing this state-of-the-art weather station. Featuring time, date, calendar, weather forecast, wind gust and wind speed, indoor/outdoor temperature and humidity, air pressure and rainfall, this weather station will provide you with various weather information and weather forecasts.

Heavy Weather Pro software allows you to use a PC to monitor and record weather data received from your wireless weather station via a proprietary USB device that was provided with your 2800 series weather station.

You can monitor and record a variety of data collected by your weather station including both indoor and external values sampled by the various weather station sensors.

You can also review weather history data, and analyze trends and tendencies over time using the software's charts and graphing features.

Download the free Heavy Weather Pro PC software at: www.heavyweather.info

INVENTORY OF CONTENTS

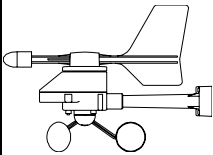
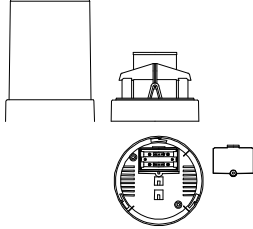
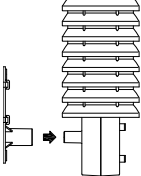
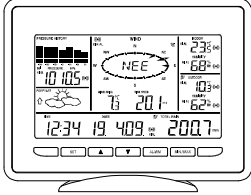
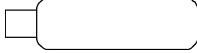
Carefully open the package and check that the following contents are complete:				
Wind Sensor	Rain Sensor	Thermo-Hygro Sensor	Wireless Display	USB Transceiver
 <ul style="list-style-type: none"> • Mast holder • Right angle adaptor • 1 x U-bolts • 2 Washers + 2 Nuts • Plastic Reset Rod 	 <ul style="list-style-type: none"> • Base sensor, funnel top cover and battery cover (pre-assembled) 	 <ul style="list-style-type: none"> • Rain protection cover • Wall mount adapter • Mounting screws • Plastic anchors for screws 	 <ul style="list-style-type: none"> • Detachable stand 	 <ul style="list-style-type: none"> • USB wireless interface for PC

FEATURES:

WIRELESS DISPLAY

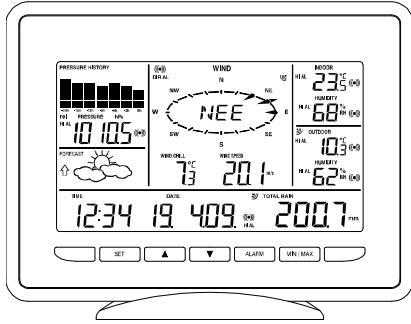

- Time display in 12/24 hour time format
- Automatic time and date (PC time) update from USB transceiver if connected
- Calendar display (date, month, year)
- Weather forecast with 3 weather icons (sunny, cloudy, and rainy) with weather tendency indicator
- Temperature display in °C/°F
- Humidity display in RH%
- Dew point display in °F/°C
- Wind chill display in °F / °C
- MIN/MAX values of indoor/outdoor temperature, indoor/outdoor humidity, dew point display with time and date of recording
- Relative air pressure reading in hPa/ inHg
- 24h/72h history graph selectable
- Wind speed displayed in km/h, m/s, mph, knots, and Beaufort scale
- Wind speed & direction with LCD compass display (16 steps/ 22.5 degree)
- MAX records for wind gust with time & date of recording
- Rainfall display in mm/inch
- Rainfall data for total rain, last hour, last 24h, last week, last month
- Weather alarm modes: temperature, humidity, wind gust, wind direction, air pressure, 24h rain and storm warning
- LCD contrast setting
- Storage of 1750 sets of weather records with user selectable recording interval from 1 minute to 24 hours

THERMO-HYGRO SENSOR

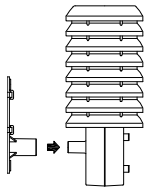

- Transmission of temperature and humidity data
- Transmission range: about 100 meters (Open field, free of obstructions)

WIND SENSOR

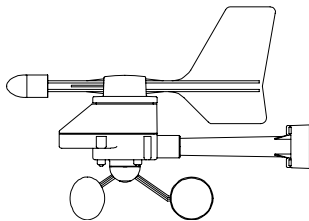

- 100% solar-powered with built-in rechargeable alkaline power cell
- High-efficient solar panels maintain operation throughout all seasons
- Transmission range: about 50 meters (Open field, free of obstructions)

RAIN SENSOR

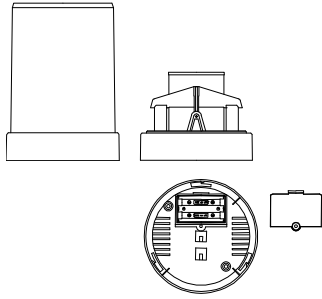

- 100% solar-powered with built-in rechargeable alkaline power cell
- High-efficient solar panels maintain operation throughout all seasons
- Self-emptying bucket
- Transmission range: about 50 meters (Open field, free of obstructions).

SETTING UP:

IMPORTANT: Make sure to observe the correct polarity when inserting batteries. The "+" markings on the batteries must line up with the diagrams inside the battery compartments. **Inserting the batteries incorrectly may result in permanent damage to the units.** During the setup process, place the wireless display and the outdoor sensors on a surface with 1-3 meters between the sensors and the display. **Only use Alkaline Batteries for the Wireless Display and Thermo-hygro sensor, rechargeable batteries may not work.**

1. It is important to allow sufficient light to reach the solar panel while activating the wind sensor. Make sure the lights are on in the setup room and the solar panel is facing a 60W light bulb or brighter - do not cover with hands or other objects. Remove the black protective foil on the solar panel and use the provided plastic reset rod to gently press the reset button once in the hole on the bottom of the sensor.
2. Twist open the top of the solar rain sensor. Remove the securing tape from the seesaw and the black protective cover from the solar panel. Swing the seesaw once to 'wake-up' the rain sensor. The solar rain sensor should then be placed under a bright environment in order to charge up the rechargeable batteries.

Press Reset Button on Bottom of the Wind Sensor (Solar Panel Must Face Light)

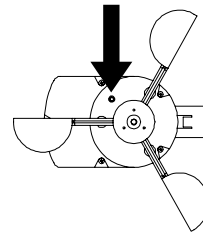

IMPORTANT: Completely reset the rain sensor:

- a. Unscrew the battery cover on bottom of the rain sensor and remove the rechargeable batteries
- b. Completely cover the solar panel to block any light source**
- c. Wait 20s, then re-insert the 2 x AA rechargeable batteries and re-screw the battery compartment back
- d. Wait 2s, and uncover the solar panel
- e. Swing the seesaw once and put the rain cover top back.

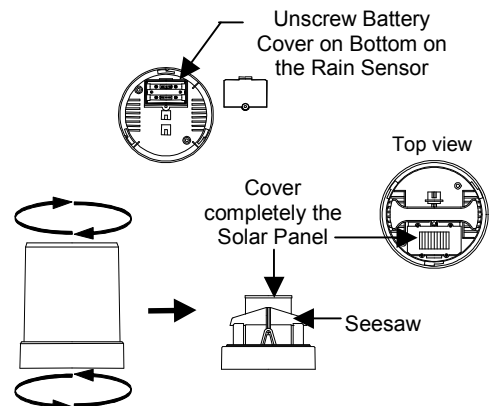

- f. Place the solar rain sensor under bright environment to charge-up the rechargeable batteries.
3. Insert two "C" size batteries into the thermo-hygro sensor with the correct polarity.
4. Insert three "C" size batteries into the wireless display with the correct polarity.

NOTE: Every time the wireless display receives data from the sensors, the wireless icons ☼ will blink once and then return to solid if the last transmission was successful. A wind speed or rainfall amount that reads "0" does not mean reception failure, it means that there was no wind or rain at the time of the last measurement. The thermo-hygro sensor syncs with the wind and rain sensors and sends all outdoor sensor data to the display. The thermo-hygro sensor tries for 7 minutes to sync to the wind sensor and for the rain sensor. If not successful within 7 minutes, the thermo-hygro sensor will stop looking for the other sensors.

5. **Setup troubleshooting:** If the sensor data fails to display for any of the outdoor sensors within 10 minutes, (" - - " is displayed), remove the batteries from all units (except for the Wind Sensor) for 1 minute and start the Setup procedure again at Step 1 **and completely reset the solar Rain Sensor (see Step 2: Important).**

ADDITIONAL NOTES FOR THE SOLAR WIND AND RAIN SENSORS MODES:

IDLE MODE

This mode aims to reduce the power consumption of the transmitter. Under this mode, the sensor stops the transmission of signal, checks the battery voltage and detects the solar cell condition. The IDLE mode happens if the battery voltage is low.

Note: The sensor will check and charge up the rechargeable battery automatically. When it detects that the battery voltage is sufficiently charged up and high enough, the transmission of signal starts again.

STOP MODE

It is the most energy saving mode. Under this mode, the transmitter stops the transmission of signal. There is no checking of the battery voltage and no detection of the solar cell condition. The STOP mode happens:

- **If the user covers the solar cell for 10 seconds and presses the RESET button (Wind Sensor).**
- **If the sensor(s) is(are) placed in the dark environment for 24 hours.**

Note:

- To restart the Solar Wind sensor, user should spin the wind cups or place the sensor in a bright environment, then press the RESET button once to wake it up again.
- To restart the Solar Rain Sensor, should swing the seesaw or, follow the SETTING UP, Step 2: Important instructions to completely reset the sensor.

IMPORTANT! During the restart process, if the battery voltage is sufficiently high enough, the transmission of signal starts again. However, if the battery voltage is low,

the sensor(s) enters the IDLE mode. User should place the sensor(s) under a bright environment in order to charge up the rechargeable batteries.

MOUNTING THE SENSORS AND PLACEMENT OF THE WIRELESS DISPLAY:

IMPORTANT: Ensure that all of the sensor data can be received at the intended mounting locations before you drill mounting holes. The outdoor sensors have a wireless range of **50 meters**. Keep in mind that the **50 meters** range equates to an open air scenario with no obstructions. Each obstruction (roof, walls, floors, ceilings, etc.) will reduce the range.

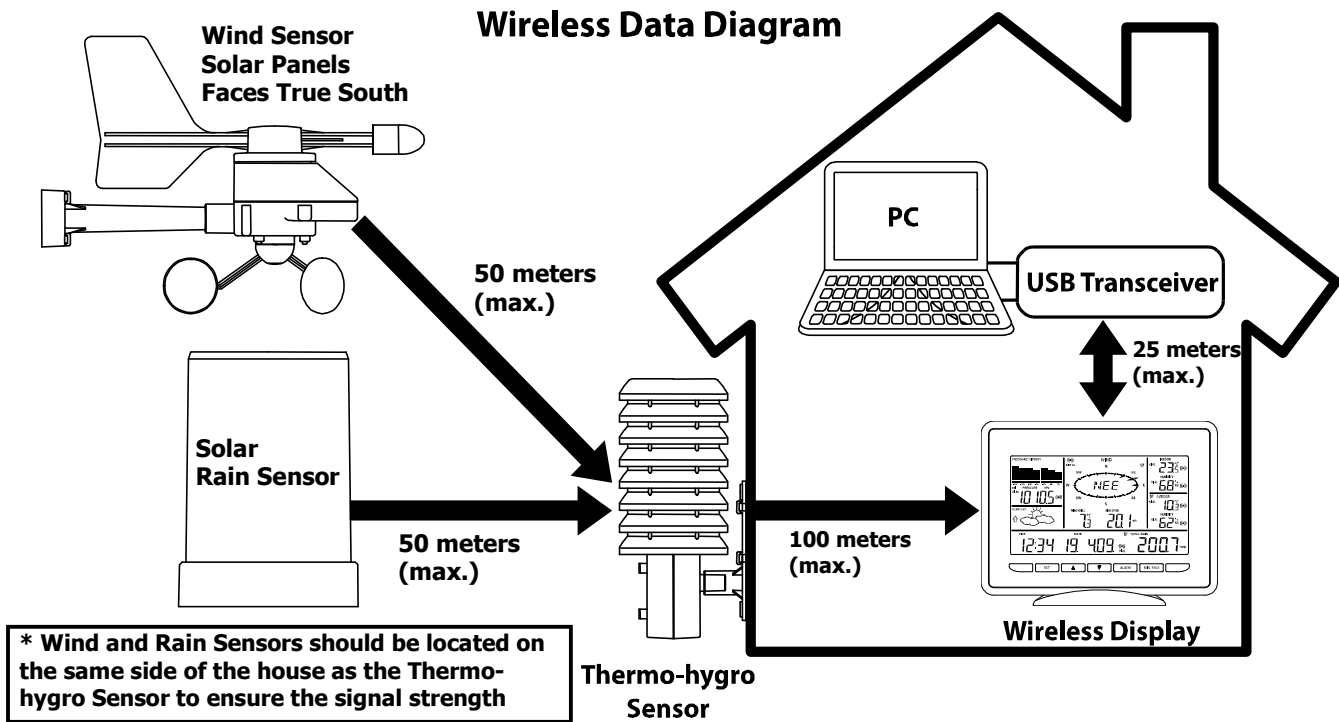

The thermo-hygro sensor measures outdoor temperature & humidity and collects the data from the wind and the rain sensors and sends all outdoor weather data to the wireless display, so the thermo-hygro sensor must be within the **100 meters** wireless range of the wireless display. This allows the wind and rain sensors to be placed relative to the thermo-hygro sensor rather than the wireless display. See Wireless Data Diagram above.

- The wind and rain sensors must be mounted within the **50 meters** wireless range of the thermo-hygro sensor and on the same side of the house.
- The wireless display must be within the **25 meters** wireless range of the USB transceiver to send weather data to the PC.

If the sensor wireless icons ☹ drop from the display as you move them into their intended locations, the sensors may be too far from the wireless display. Try moving the wireless display or the sensors closer and wait a few minutes to see if the wireless icons ☹ display again. If the wireless icons ☹ are still not displayed after re-positioning

the sensors or the wireless display, press and hold the ▲UP ARROW key for 2 seconds to re-synchronize the wireless display with the sensors.

WIND SENSOR

The wind sensor must be installed **with the front of the sensor (the solar panel) facing true South**, or the reported wind direction will not be accurate. Mount within the **50 meters** wireless range of the thermo-hygro sensor and on the same side of the house. The roof may or may not be an ideal mounting location. Secure the main unit to the shaft of the mast holder. Use the right-angle adaptor if the wind sensor will be mounted on a horizontal mast or surface.

Fasten the wind sensor to a suitable mast using the two U-bolts, washers and nuts included. **Note:** Mount the wind sensor onto a mast so the wind can reach the sensor unobstructed from all directions for an accurate reading. The ideal mast is between 15.75mm and 33mm in diameter. The wind sensor DOES NOT have replaceable batteries, it consumes solar power and charges the internal battery pack automatically.

RAIN SENSOR

The rain sensor should be mounted on a level surface in an open area and bright area within the **50 meters** wireless range of the thermo-hygro sensor and on the same side of the house. Mount the rain sensor at least 0.30 meter off the ground level for optimum wireless transmission. The rain sensor should be accessible to allow for period cleaning of debris or insects.

THERMO-HYGRO SENSOR

The thermo-hygro sensor is "weather resistant", but not "water proof". To ensure an extended life of your sensor, mount it in a semi-covered place out of the elements. An ideal location for the thermo-hygro sensor is under the eaves on the North side of the house to avoid the effects of sunlight. Mount the sensor 0.5 meter down from the eaves to ensure optimum performance. This way the weather data collected by the sensor will not be affected by the temperature of the air coming out of the attic.

To wall mount the thermo-hygro sensor, fix the wall holder onto the desired wall using the included screws, plug the sensor firmly into the wall holder and replace the rain cover if it is not already in place. **Note:** After mounting the units, if the weather data is not received, press and hold the ▲UP ARROW key for 2 seconds to synchronize the wireless display to the sensors.

HEAVY WEATHER PC SOFTWARE

Use your PC to store and graph the latest weather data collected by the weather station. Download the Heavy Weather PC software from www.heavyweather.info

The Heavy Weather Pro User's Guide available on the download page details the computer requirements, installation and usage instructions.

FUNCTION KEYS:

SET key

- Press and hold for 3 seconds to enter the SET mode, where the following can be changed: LCD contrast, Manual time setting, 12/24 hour time display, Calendar setting, °F/ °C temperature unit, Wind speed unit, Rainfall unit, Pressure unit, Relative pressure reference setting, Weather tendency threshold setting, Storm warning threshold setting and Storm Alarm On/ Off setting, Wind direction display type, Factory reset
- Press to toggle between the display of Mode 1 or Mode 2:
- **Mode 1:** "Wind speed + outdoor temp + 24 hr. pressure history graph"
- **Mode 2:** "Gust + Dew Point temp + 72 hr. pressure history graph "
- In the weather alarm setting mode, press and release to switch the weather alarm On/ Off
- In the weather alarm setting mode, press and hold to adjust the weather alarm value
- Stop the alarm during the time alarm or weather alarm ringing

▲ UP ARROW key

- Press to toggle between the display of seconds or date in the time display
- Press to increase the level of different settings in SET mode
- Stop the alarm during the time alarm or weather alarm ringing
- Press to reset the MIN/MAX record when in MIN/MAX display mode
- Press and hold for 2 seconds to synchronize the Wireless Display to the sensors

▼ DOWN ARROW key

- Press to switch the rainfall display mode: Total, 1h, 24h, week, month
- Press to decrease the level of different settings in SET mode
- Stop the alarm during the time alarm or weather alarm ringing

ALARM key

- Press to enter the time alarm and weather alarm setting mode
- Confirm particular alarm setting
- Press to exit the manual setting mode
- Stop the alarm during the time alarm or weather alarm ringing
- Press to exit max/ min record display mode

MIN/MAX key

- Press to display minimum and maximum records of various weather data
- Stop the alarm during the time alarm or weather alarm ringing
- Press to exit the manual setting mode
- Press to exit the weather alarm setting mode

LCD SCREEN

When the signal from the transmitter is successfully received by the Weather Station, the ☼ icon will be switched on. (If not successful, the ☼ icon will not be shown on the LCD). User can see whether the last reception was successful (☼ icon is on) or not (☼ icon is off). Blinking of the ☼ icon shows that a reception is in process.

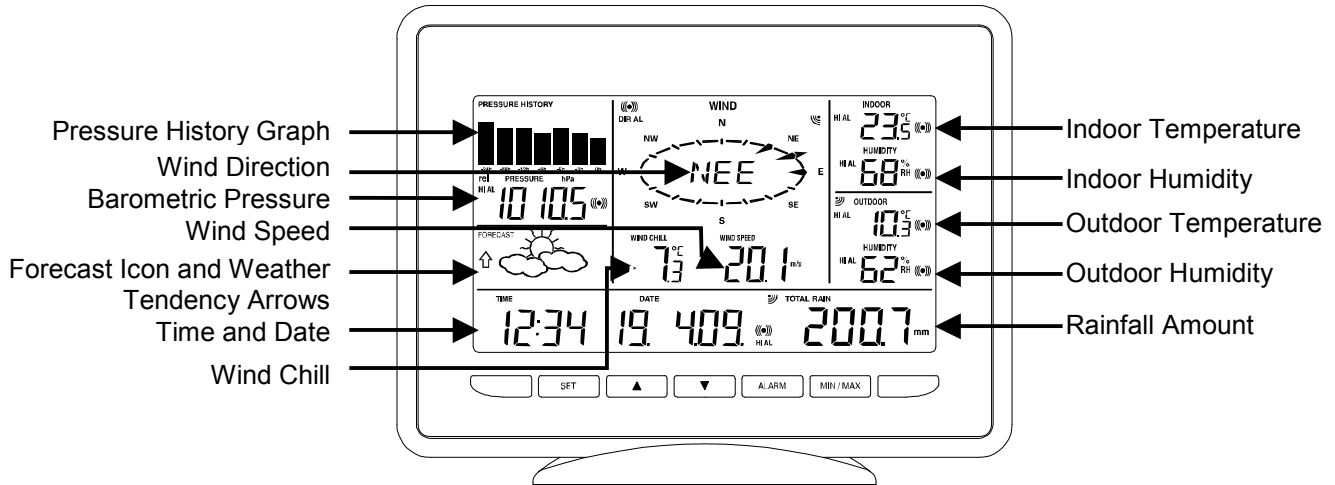

- Press the SET key to toggle between Mode 1 and Mode 2 display:

Mode 1 display:

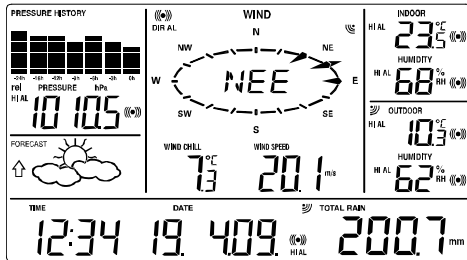

- Pressure history graph displays 24 hour history
- Outdoor temperature displayed in the outdoor section
- Wind speed displayed in the wind section

MODE 2 DISPLAY:

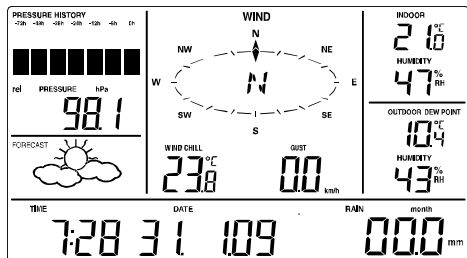

- Pressure history graph displays 72 hour history
- Dew point displayed in the outdoor section
- Wind gust displayed in the wind section

MANUAL SETTINGS

Press and hold the SET key for 3 seconds to enter the SET mode. If you wait 30 seconds without pressing any keys while in SET mode, the display will automatically return to Mode 1 display.

While in SET mode, each press of the SET key will advance to the next SET mode item.

1. LCD contrast setting
2. Manual time setting
3. 12/24 hour time display
4. Calendar setting
5. °F/ °C temperature unit setting
6. Wind speed unit
7. Rainfall unit setting
8. Air pressure unit setting
9. Relative pressure reference value setting
10. Weather tendency threshold value
11. Storm warning threshold value
12. Storm alarm On/ Off setting
13. Wind direction display type
14. Factory Reset

LCD CONTRAST SETTING

The LCD contrast can be set within 8 levels, from "Lcd 1" to "Lcd 8" (default setting is "Lcd 5"):

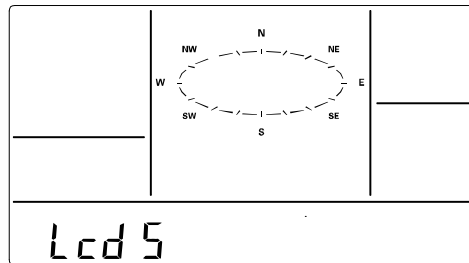

1. Press and hold the SET key for 3 seconds, the contrast level digit will start flashing.
2. Press the ▲UP ARROW key or ▼DOWN ARROW key to adjust the level of contrast.
3. Press the SET key to confirm and to enter the **MANUAL TIME SETTING**.

MANUAL TIME SETTING

The time will be updated automatically with the time from the computer when the display is synchronized with the USB transceiver and connected to the Heavy Weather Pro software. The time can also be set manually by following the steps below:

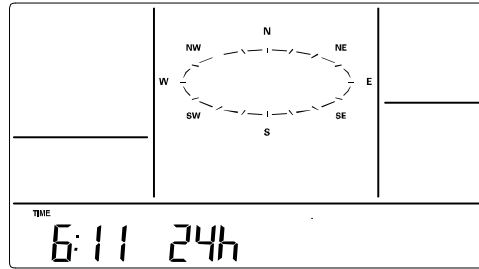

1. The hour digit is flashing.
2. Press the ▲UP ARROW key or ▼DOWN ARROW key to set the hour. Continually holding the key will increase the digit faster.
3. Press the SET key to switch to the minutes. The minute digit will start flashing.
4. Press the ▲UP ARROW key or ▼DOWN ARROW key to set the minute. Continually holding the key will increase the digit faster.
5. Press the SET key to confirm and to enter the **12/24 HOUR TIME DISPLAY SETTING**.

12/24 HOUR TIME DISPLAY SETTING

The time can be set to view as 12-hour or 24-hour format. The default time-display mode is *24-h*. To set to *12-h* time display:

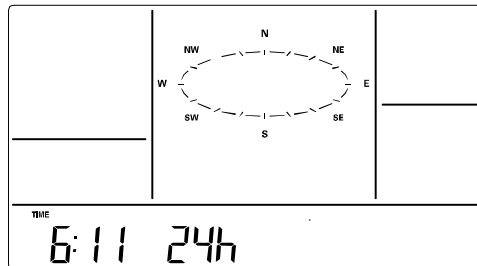

1. The 24h or 12h digit is flashing
2. Press the ▲UP ARROW key or ▼DOWN ARROW key to toggle the value.
3. Press the SET key to confirm and to enter the **CALENDAR SETTING**.

Remarque:

- 24h time display format will show: Day/ Month/ Year
- 12h time display format will show: Month/ Day/ Year

CALENDAR SETTING

The default date is 1. 1. of year 2009. The date will be updated automatically with the date from the computer when the display is synchronized with the USB transceiver and connected to the Heavy Weather Pro software. The date can also be set manually by following the steps below.

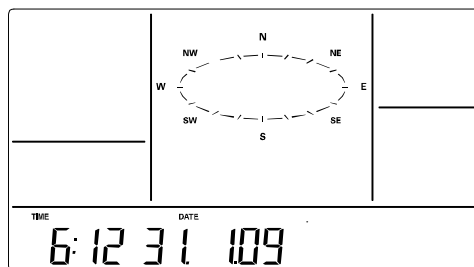

1. The year digit starts flashing.
2. Press the ▲UP ARROW key or ▼DOWN ARROW key to set the year. The range runs from "00" (2000) to "99" (2099). Hold the key in to change the value faster.
3. Press the SET key to confirm the year and enter the month setting. The month digit will start flashing.
4. Press the ▲UP ARROW key or ▼DOWN ARROW key to set the month. Hold the key in to change the value faster..
5. Press the SET key to confirm the month and enter the date setting mode. The day digit will start flashing.
6. Press the ▲UP ARROW key or ▼DOWN ARROW key to set the day. Hold the key in to change the value faster..
7. Press the SET key to confirm and to enter the **°F/°C TEMPERATURE UNIT SETTING**.

°F/°C TEMPERATURE UNIT SETTING

The temperature can be displayed in °C or °F. (default °C).

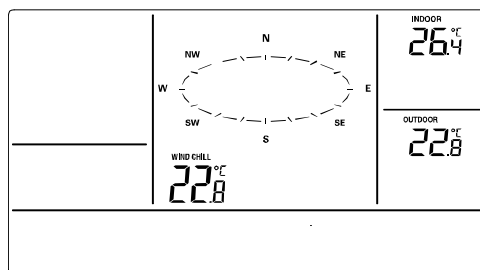

1. The temperature unit is flashing
2. Press the ▲UP ARROW key or ▼DOWN ARROW key to toggle between "°F" or "°C".
3. Press the SET key to confirm and to enter the **WIND SPEED UNIT SETTING**.

WIND SPEED UNIT SETTING

The wind speed unit can be set as mph (mile per hour), km/h (kilometer per hour), knots, Bft (Beaufort scale), or m/s (meter per second). The default unit is km/h.

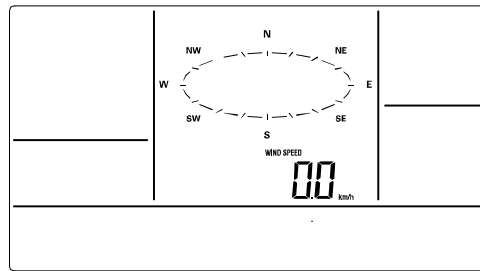

1. The wind speed unit is flashing.
2. Press the ▲UP ARROW key or ▼DOWN ARROW key to toggle between the unit “mph”, “km/h”, “bft”, “knots” or “m/s”.
3. Press the SET key to confirm and to enter the **RAINFALL UNIT SETTING**.

RAINFALL UNIT SETTING

The rainfall unit can be set as inch or mm. The default unit is mm.

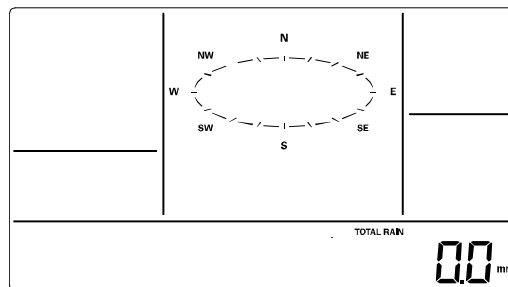

1. The rainfall unit is flashing.
2. Press the ▲UP ARROW key or ▼DOWN ARROW key to toggle between the unit “inch” or “mm”
3. Press the SET key to confirm and to enter the **RELATIVE AIR PRESSURE UNIT SETTING**

RELATIVE AIR PRESSURE UNIT SETTING

The relative air pressure can be set as inHg or hPa. The default unit is hPa.

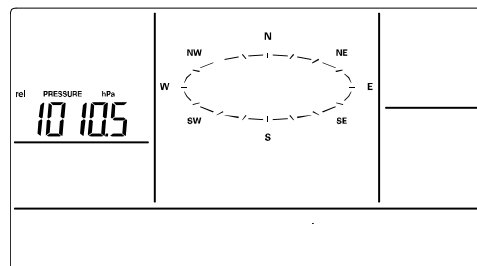

1. The relative air pressure unit is flashing.
2. Press the ▲UP ARROW key or ▼DOWN ARROW key to toggle between the unit “inHg” or “hPa”
3. Press the SET key to confirm and to enter the **RELATIVE PRESSURE REFERENCE VALUE SETTING**.

RELATIVE PRESSURE REFERENCE VALUE SETTING

 **Note:** The default reference pressure-value of the barometer is 1013 hPa when batteries are first inserted. **For an exact measurement, it is necessary to first adjust the barometer to your local relative air pressure (related to elevation above sea level).** Ask for the current atmospheric pressure of your home area (Local weather service, the world wide web, optician, calibrated instruments in public buildings, airport).

 **Note:** This feature is useful for those who live at elevations above sea level, but want their air pressure display to be based on sea level elevation.

The relative air pressure can be manually set to another value within the range of 920 to 1080 hPa (27.10 to 31.90 inHg) for a better reference.

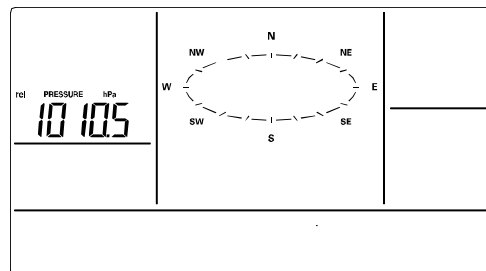

1. The current relative pressure value will start flashing
2. Press the ▲UP ARROW key or ▼DOWN ARROW key to increase or decrease the value. Continually holding the key will allow the value to increase faster.
3. Press the SET key to confirm and to enter the **WEATHER TENDENCY SENSITIVITY VALUE SETTING.**

WEATHER TENDENCY SENSITIVITY LEVEL SETTING

Set the switching sensitivity value, 2,3 or 4 hPa (.06, .09, or .12 inHg) for the change in the display of weather icons. This represents the "sensitivity" of the weather forecast (the smaller the value selected, the more sensitive the weather forecast). The default value is 3 hPa. Select lower numbers for high humidity areas, i.e. Oceanside. Select high numbers for arid areas, i.e. desert.

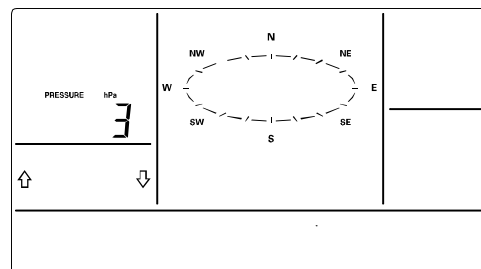

1. The sensitivity value and tendency arrow will start flashing
2. Press the ▲UP ARROW key or ▼DOWN ARROW key to select the value.
3. Press the SET key to confirm and to enter the **STORM WARNING SENSITIVITY SETTING.**

STORM WARNING THRESHOLD VALUE SETTING

Define a switching sensitivity value for the Storm warning display at a decrease of air pressure from 3hPa to 9hPa (.09 inHg to .27 inHg) over 6 hours. (Default 5 hPa).

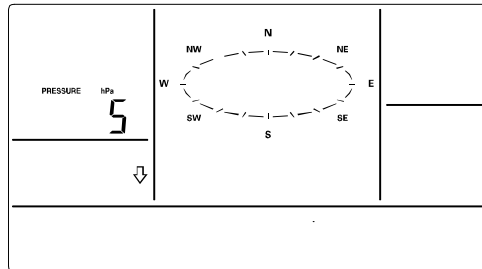

1. The sensitivity value and tendency arrows will start flashing.
2. Press the ▲UP ARROW key or ▼DOWN ARROW key to select the value.
3. Press the SET key to confirm and to enter the **STORM ALARM ON/OFF SETTING**.

STORM ALARM ON/ OFF SETTING

Switch the Storm Warning Alarm On or Off (Default OFF).

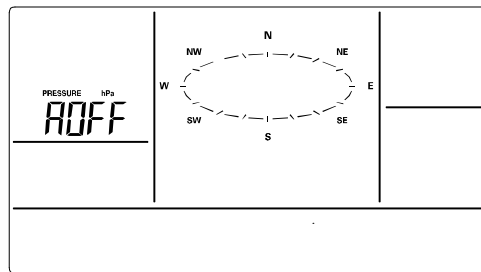

1. The digit "AOFF" will start flashing.
2. Press the ▲UP ARROW key or ▼DOWN ARROW key to switch On or Off the alarm. ("AOFF" = Off; "AON" = On)
3. Press the SET key to confirm and to enter the **WIND DIRECTION DISPLAY TYPE SETTING**.

 **Note:** If a storm warning alarm is activated, the downward weather tendency arrow will be flashing. (See WEATHER TENDENCY INDICATOR below).

WIND DIRECTION DISPLAY TYPE SETTING

The wind direction can be displayed using either compass directions or degree measurements (default setting is compass directions).

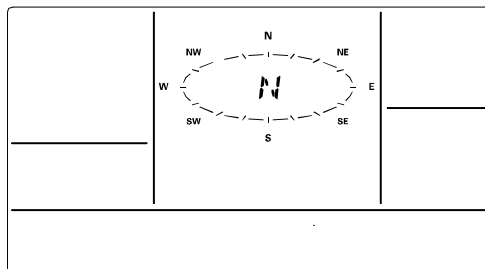

1. The wind direction will start flashing.
2. Press the ▲UP ARROW key or ▼DOWN ARROW key to toggle from compass directions to degree measurements.
3. If you do not wish to reset the display to factory defaults, simply press the ALARM or MIN/MAX key, or wait until the SET mode times out and returns to the normal display mode.
4. If you wish to perform a FACTORY RESET, press the SET key to confirm and to enter the **FACTORY RESET PROCEDURE**. SEE WARNINGS in the FACTORY RESET section.

FACTORY RESET PROCEDURE



WARNING:

Performing a factory reset will erase all MIN/MAX values and weather data stored in the display's internal memory and return the weather units settings back to the factory defaults. If you have not yet uploaded the data to the Heavy Weather Pro software, the data will be lost.

If you do not wish to reset the display to factory defaults either:

- press the MIN/MAX key or the ALARM key, or
- simply wait until the SET mode times out and returns to the Mode 1 display (normal mode).

To reset the display to factory defaults, follow the procedure below:



WARNING:

A factory reset will erase the connection between the display and the thermo-hygro sensor and require the connection to be re-established.

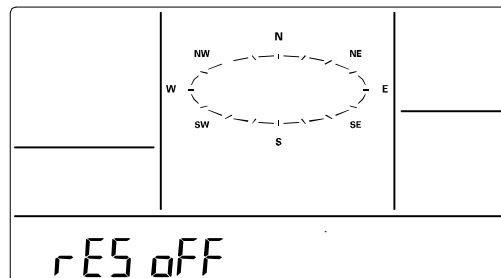

1. "rES OFF" will start flashing.
2. Use the ▲UP ARROW key to turn "rES on".
3. Press the SET key to confirm and a countdown timer will begin counting down from "127". When the timer displays "dOnE", you must remove the batteries from the display for 10 minutes. While the batteries are out of the display, also remove the batteries from the thermo-hygro sensor.
4. After waiting for 10 minutes, insert the batteries into the thermo-hygro sensor, making sure to align the "+" symbol on the batteries with the markings on the battery cover and inside the battery compartment.

5. Within 2 minutes of inserting the batteries into the thermo-hygro sensor, insert the batteries into the display, making sure to align the "+" symbol on the batteries with the markings inside the battery compartment.
6. Wait 5 minutes for the outdoor weather data to display. If any of the outdoor data displays "--" after waiting for 5 minutes, follow the "Setting Up" Procedure near the beginning of this manual or in the Quick Set Up Manual included with the product.

TO EXIT THE MANUAL SETTING MODE

To exit the manual setting anytime during the manual setting modes, either:

- Press the ALARM key or the MIN/MAX key or
- Simply wait 30 seconds until the SET mode time out and return to the Mode 1 display (normal mode).

WEATHER ALARM OPERATIONS

The Weather alarms can be set when certain weather conditions are met according to your requirements. For example, you can set the thresholds for the outdoor temperature to +40°C (high) and -10°C (low), while enabling the high alarm and disabling the low alarm (i.e. temperatures <-10°C won't trigger alarm, but temperatures >+40°C will).

- If the value meets the condition for high alarm or low alarm, the buzzer will ring for 2 minutes and the value will blink, along with the corresponding icon ("HI AL"/ "LO AL").
- Press any key to stop a ringing alarm.
- The high and low alarms can be switched On/Off independently, according to your needs.
- If at any time during the alarm setting process you would like to exit alarm setting mode, press the MIN/MAX key or wait for about 30 seconds and the display will return to normal display mode automatically.
- In normal display mode, press the ALARM key to enter ALARM mode. Subsequent presses of the ALARM key will advance to the next weather alarm section.



Note: Weather alarms can also be set from the Heavy Weather Pro software. Consult the Heavy Weather Pro User's Guide for instructions.

THE FOLLOWING WEATHER ALARMS CAN BE ADJUSTED IN ALARM SETTING MODE

- High and Low pressure alarms
- High and Low indoor temperature alarms
- High and Low indoor humidity alarms
- High and Low outdoor temperature alarms
- High and Low outdoor humidity alarms
- High wind gust alarm
- Wind direction alarm
- High rainfall amount in 24 hour period alarm

DEFAULT WEATHER ALARM VALUES

Pressure	Low	960 hPa	Wind gust	High	100 km/h
	High	1040 hPa		Rainfall in 24 hours	High
Temperature (In or Out)	Low	0°C			
	High	40°C			
Relative Humidity (In or Out)	Low	45%			
	High	70%			

PRESSURE ALARMS

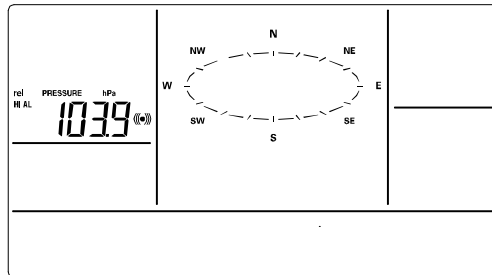

1. In the normal display mode, press the ALARM key once. The high pressure alarm display will be shown.
2. Press and hold the SET key for about 2 seconds. The pressure digit will start flashing.
3. Press the ▲UP ARROW key or ▼DOWN ARROW key to set the high pressure alarm value. Hold the arrow key in to change the value faster.
4. Press the ALARM key to confirm the setting. The digit will stop flashing.
5. Press the SET key to switch the alarm on or off. The ((•)) icon indicates the alarm is switched on.
6. Press the ALARM key once. The Low Pressure alarm display will be shown.
7. Press and hold the SET key for about 2 seconds. The pressure digit will start flashing.
8. Press the ▲UP ARROW key or ▼DOWN ARROW key to set the low pressure alarm value. Hold the arrow key in to change the value faster.
9. Press the ALARM key to confirm the setting. The digit will stop flashing.
10. Press the SET key to switch the alarm on or off. The ((•)) icon indicates the alarm is switched on.
11. Press the ALARM key to move to the indoor temperature alarm settings.

INDOOR TEMPERATURE ALARMS

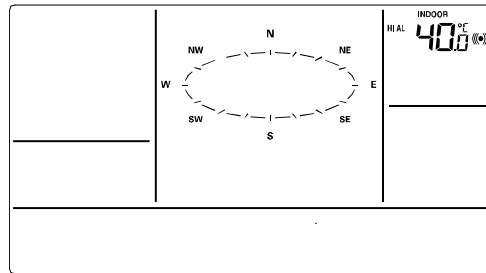

1. The high indoor temperature alarm display will be shown.
2. Press and hold the SET key for about 2 seconds. The temperature digit will start flashing.
3. Press the ▲UP ARROW key or ▼DOWN ARROW key to set the high indoor temperature alarm value. Hold the key in to change the value faster.
4. Press the ALARM key to confirm the setting. The digit will stop flashing.
5. Press the SET key to switch the alarm on or off. The ((•)) icon indicates that the alarm is switched on.
6. Press the ALARM key once. The low indoor temperature alarm display will be shown.
7. Press and hold the SET key for about 2 seconds. The temperature digit will start flashing.
8. Press the ▲UP ARROW key or ▼DOWN ARROW key to set the low indoor temperature alarm value. Hold the arrow key in to change the value faster.
9. Press the ALARM key to confirm the setting. The digit will stop flashing.
10. Press the SET key to switch the alarm on or off. The ((•)) icon indicates the alarm is switched on.
11. Press the ALARM key to move to the indoor humidity alarm settings.

INDOOR HUMIDITY ALARMS

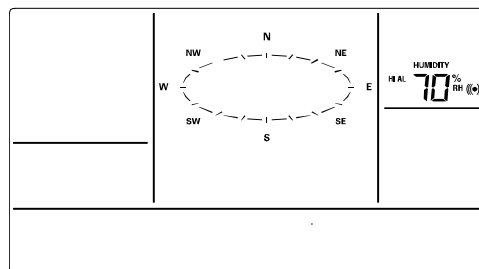

1. The high indoor humidity alarm display will be shown.
2. Press and hold the SET key for about 2 seconds. The humidity digit will start flashing.
3. Press the ▲UP ARROW key or ▼DOWN ARROW key to set the high indoor humidity alarm value. Hold the key in to change the value faster.
4. Press the ALARM key to confirm the setting. The digit will stop flashing.
5. Press the SET key to switch the alarm on or off. The ((•)) icon indicates the alarm is switched on.

6. Press the ALARM key once. The low indoor humidity alarm display will be shown.
7. Press and hold the SET key for about 2 seconds. The humidity digit will start flashing.
8. Press the ▲UP ARROW key or ▼DOWN ARROW key to set the low indoor humidity alarm value. Hold the key in to change the value faster.
9. Press the ALARM key to confirm the setting. The digit will stop flashing.
10. Press the SET key to switch the alarm on or off. The (((•))) icon indicates the alarm is switched on.
11. Press the ALARM key to move to the outdoor temperature alarm settings.

OUTDOOR TEMPERATURE ALARMS

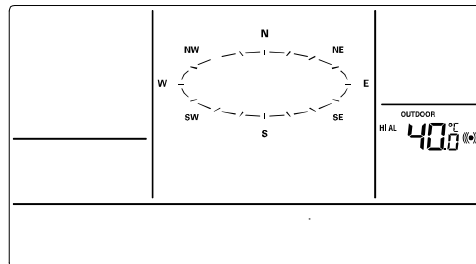

1. The high outdoor temperature alarm display will be shown.
2. Press and hold the SET key for about 2 seconds. The temperature digit will start flashing.
3. Press the ▲UP ARROW key or ▼DOWN ARROW key to set the high outdoor temperature alarm value. Hold the key in to change the value faster.
4. Press the ALARM key to confirm the setting. The digit will stop flashing.
5. Press the SET key to switch the alarm on or off. The (((•))) icon indicates that the alarm is switched on.
6. Press the ALARM key once. The low outdoor temperature alarm display will be shown.
7. Press and hold the SET key for about 2 seconds. The temperature digit will start flashing.
8. Press the ▲UP ARROW key or ▼DOWN ARROW key to set the low outdoor temperature alarm value. Hold the arrow key in to change the value faster.
9. Press the ALARM key to confirm the setting. The digit will stop flashing.
10. Press the SET key to switch the alarm on or off. The (((•))) icon indicates the alarm is switched on.
11. Press the ALARM key to move to the outdoor humidity alarm settings.

OUTDOOR HUMIDITY ALARMS

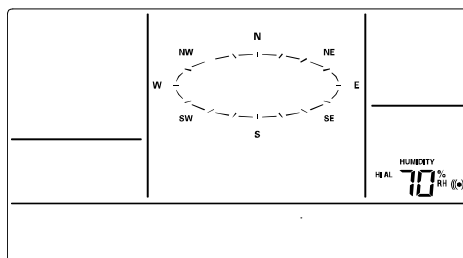

1. The high outdoor humidity alarm display will be shown.
2. Press and hold the SET key for about 2 seconds. The humidity digit will start flashing.
3. Press the ▲UP ARROW key or ▼DOWN ARROW key to set the high outdoor humidity alarm value. Hold the key in to change the value faster.
4. Press the ALARM key to confirm the setting. The digit will stop flashing.
5. Press the SET key to switch the alarm on or off. The (((•))) icon indicates the alarm is switched on.
6. Press the ALARM key once. The low outdoor humidity alarm display will be shown.
7. Press and hold the SET key for about 2 seconds. The humidity digit will start flashing.
8. Press the ▲UP ARROW key or ▼DOWN ARROW key to set the low outdoor humidity alarm value. Hold the key in to change the value faster.
9. Press the ALARM key to confirm the setting. The digit will stop flashing.
10. Press the SET key to switch the alarm on or off. The (((•))) icon indicates the alarm is switched on.
11. Press the ALARM key to move to the wind gust alarm settings.

WIND GUST ALARM

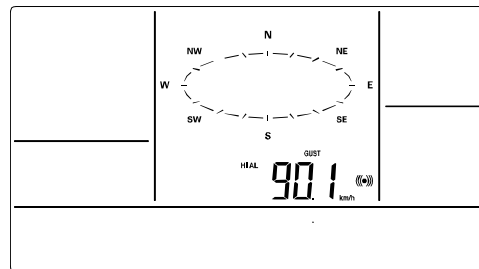

1. The wind gust alarm display will be shown.
2. Press and hold the SET key for about 2 seconds. The wind gust digit will start flashing.
3. Press the ▲UP ARROW key or ▼DOWN ARROW key to set the wind gust alarm value. Hold the key in to change the value faster.
4. Press the ALARM key to confirm the setting. The digit will stop flashing.
5. Press the SET key to switch on or off the alarm. The (((•))) icon indicates the alarm is switched on.
6. Press the ALARM key to move to the wind direction alarm settings.

WIND DIRECTION ALARM



Note: Multiple wind direction alarms can be set simultaneously if desired.

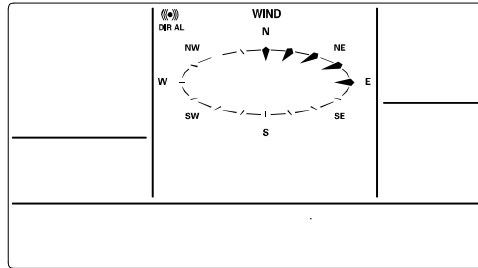

1. The wind direction alarm display will be shown.
2. Press and hold the SET key for about 2 seconds. The wind direction arrow on the outside of the compass circle will start flashing with the corresponding compass direction or degrees reading displayed in the center of the compass.
3. Press the ▲UP ARROW key or ▼DOWN ARROW key to move the wind direction alarm pointer.
4. Press the SET key to set a wind direction alarm. A pointer icon will appear inside of the compass circle to indicate an alarm setting for that wind direction.
5. To remove an alarm setting for a wind direction, press the SET key again to remove the selected wind direction alarm. The arrow icon inside the compass circle will disappear.
6. If more than one wind direction is desired as an alarm setting, Press the ▲UP ARROW key or ▼DOWN ARROW key to move the wind direction alarm pointer to the next desired setting.
7. Press the SET key to confirm the next wind direction. A pointer icon will appear inside of the compass circle to indicate an alarm setting for that wind direction. You can set as many wind direction alarms as you desire.
8. Press the ALARM key to confirm the setting. The wind direction arrow will stop flashing.
9. Press the SET key to switch on or off the alarm. The ((•)) icon indicates the alarm is switched on.
10. Press the ALARM key to move to the 24h rainfall alarm settings.

24H RAINFALL ALARM

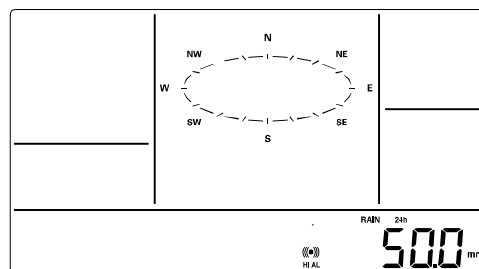

1. The 24h rainfall alarm display will be shown.
2. Press and hold the SET key for about 2 seconds. The 24h rainfall digit will start flashing.
3. Press the ▲UP ARROW key or ▼DOWN ARROW key to set the 24h rainfall value. Hold the key in to change the value faster.
4. Press the ALARM key to confirm the setting. The digit will stop flashing.

5. Press the SET key to switch on or off the alarm. The (((•))) icon indicates the alarm is switched on.
6. Press the ALARM key to exit the alarm settings.

HYSTERESIS

To compensate for fluctuation of the measured data, which may cause the weather alarm to sound constantly if the measured reading is close to your set level, a hysteresis function has been implemented for each weather alarm. For example, if the high temperature alarm is set to +25°C and the current value moves to +25°C, the alarm will be activated (if it has been enabled).

Weather data	Hysteresis
Temperature	1°C
Humidity	3% RH
Pressure	1 hPa
Wind speed	10 km/h



Now when the temperature drops to +24.88°C or below and thereafter again increases to beyond +25°C, the data will be blinking, but no alarm will be activated. It has to drop to below +24°C (with a pre-set hysteresis of 1°C) so that the alarm can be produced again. Hysteresis values for the various weather data types are given in the table.

 **Note:** The temperature or humidity data will keep flashing even after a key has been pressed to stop the alarm has been switched off to indicate that the current weather condition is out of the pre-set limit(s)

WEATHER FORECAST AND WEATHER TENDENCY

WEATHER FORECASTING ICONS:

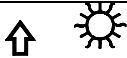
Weather forecasting icons are displayed in any of the following combinations:

		
Sunny	Cloudy with sunny intervals	Rainy

For every sudden or significant change in the air pressure, the weather icons will update accordingly to represent the change in weather.

(Every time a new average pressure value has been obtained (once per minute), this value is compared with an internal reference value. If the difference between these values is bigger than the selected weather tendency sensitivity, the weather-icon changes, either for worse or for better. In this case, the current pressure value becomes the new weather tendency reference.)

If the icons do not change, either the air pressure has not changed or the change has been too small for the Weather Center to register. So you may adjust the "sensitivity" of the pressure change checking in the setting mode –see **WEATHER TENDENCY SENSITIVITY VALUE SETTING** above.

However, if the icon displayed is a sun or raining cloud, there will be no change of icon if the weather gets any better (with sunny icon) or worse (with rainy icon) since the icons are already at their extremes.

The icons displayed forecasts the weather in terms of getting better or worse and not necessarily sunny or rainy as each icon indicates. For example, if the current weather is cloudy and the rainy icon is displayed, it does not mean that the product is faulty because it is not raining. It simply means that the air pressure has dropped and the weather is expected to get worse but not necessarily rainy.

 **Note:** After setting up, readings for weather forecasts should be disregarded for the next 48-60 hours. This will allow sufficient time for the Weather station to collect air pressure data at a constant altitude and therefore result in a more accurate forecast.

Common to weather forecasting, absolute accuracy cannot be guaranteed. The weather forecasting feature is estimated to have an accuracy level of about 75% due to the varying areas the Weather Center has been designed for use. In areas that experience sudden changes in weather (for example from sunny to rain), the Weather Center will be more accurate compared to use in areas where the weather is stagnant most of the time (for example mostly sunny).

If the Weather Center is moved to another location significantly higher or lower than its initial standing point (for example from the ground floor to the upper floors of a house), discard the weather forecast for the next 48-60 hours, as the Weather Center may mistake the new location as being a possible change in air-pressure when really it is due to the slight change of altitude.

WEATHER TENDENCY INDICATOR

Working together with the weather icons is the weather tendency indicators (arrow located on the left and right sides of the weather icons). When the indicator points upwards, it means that the air-pressure is increasing and the weather is expected to improve, but when indicator points downwards, the air-pressure is dropping and the weather is expected to become worse.

Taking this into account, one can see how the weather has changed and is expected to change. For example, if the indicator is pointing downwards together with cloud and sun icons, then the last noticeable change in the weather was when it was sunny (the sun icon only). Therefore, the next change in the weather will be cloud with rain icons since the indicator is pointing downwards.

 **Note:** Once the weather tendency indicator has registered a change in air pressure, it will remain permanently visualized on the LCD.

AIR PRESSURE HISTORY (ELECTRONIC BAROMETER WITH BAROMETRIC PRESSURE TREND)

The LCD also shows the relative air pressure value and the air pressure history.

Press the SET key to toggle between Mode1 and Mode2 of the display.

- **Mode 1:** the bar graph displays the air pressure history of the past 24 hours in seven steps. The horizontal axis represents the last 24 hours of air pressure recording (-24, -18, -12, -9, -6, -3 and 0 hour).

- **Mode 2:** the bar graph displays the air pressure history of the past 72 hours in seven steps. The horizontal axis represents the last 72 hours of air pressure recording (-72, -48, -36, -24, -12, -6 and 0 hour).

The vertical bars are plotted at each of the nine steps and give the trend over the recorded period. The 0 hour vertical bar will always display at the midline height to indicate the current air pressure. The varying height of bars in other columns on the graph indicate a relative change in air pressure up or down from the previous measurement.

New pressure measurements are compared to previously recorded pressure measurements. The pressure change is expressed by the difference between the current ("0h") and the past readings in divisions of ± 0.06 inHg or ± 2 hPa. If the bars are rising from left to right, this indicates that the weather is getting better due to an increase in air pressure. If the bars are falling from left to right, this indicates that the weather is expected to get worse due to a drop in air pressure.

At every full hour, the current air pressure is used as a basis for the display of a new graph bar. The existing graph is then moved one column to the left.

 **Note:** For accurate barometric pressure trend, the Weather Center should operate at the same altitude. For example, it should not be moved. Should the unit be moved, for instance from the ground to the second floor of the house, the readings for the next 48-60 hours shall be discarded.

 **Note:** The bar graph will scroll right to left regularly to prevent LCD burnout.

WIND DIRECTION AND WIND SPEED MEASUREMENT

- The current wind direction is indicated by a pointer on the outer circle of the compass.
- The last 6 wind directions are displayed with pointers on the inner circle.
- The wind direction (abbreviation or degrees) is displayed in center of compass. Press the SET key to toggle between Mode 1 and Mode 2 of the display

Mode 1 displays the following wind data:

- Wind direction (shown on the compass scale of 16 divisions)
- Wind chill in $^{\circ}\text{C}$ or $^{\circ}\text{F}$
- Wind **speed** in km/h, mph, bft, knots or m/s

Mode 2 displays the following wind data:

- Wind direction (shown on the compass scale of 16 divisions)
- Wind chill in $^{\circ}\text{C}$ or $^{\circ}\text{F}$
- Wind **gust** in km/h, mph, bft, knots or m/s

RAINFALL MEASUREMENT

The 1 hour, 24 hour, week, month or total rainfall measurement is displayed on the LCD, in the unit of mm or inch.

- Press the ▼DOWN ARROW to select the rainfall display from the following modes:
 1. Total rainfall - reset manually (see "RESET THE MIN/MAX WEATHER DATA")
 2. Last 1 hour rainfall – reset every four minutes, totals last 15 measurements
 3. Last 24 hours rainfall - reset every day at 12:00am (midnight)
 4. Last week rainfall - reset every Monday night at 12:00am (midnight)
 5. Last month rainfall - reset every 1st of month at 12:00am (midnight)

VIEWING THE MIN/MAX WEATHER DATA

The weather station will record the maximum and minimum value of the various weather data with time and date of recording automatically. The following stored maximum and minimum weather data can be viewed by pressing the MIN/MAX key in normal display mode.

1. MIN/MAX indoor temperature with the date and time of recording
2. MIN/MAX indoor humidity with the date and time of recording
3. MIN/MAX outdoor temperature with the date and time of recording
4. MIN/MAX dew point temperature with the date and time of recording
5. MIN/MAX outdoor humidity with the date and time of recording
6. MAX wind gust with the date and time of recording
7. Total rainfall with the date and time of recording

RESET THE MINIMUM AND MAXIMUM WEATHER DATA

To reset the aforementioned MIN/MAX weather data, you need to reset each of the data independently.

1. Press MIN/MAX key to show the desired weather data.
2. Press ▲UP ARROW key. The stored value will be reset to the current value and current time.

TOTAL RAINFALL AMOUNT

The total rainfall measurement is displayed in the unit of mm or inch. It shows the total rainfall accumulated since last reset of the total rainfall amount.

In either Mode 1 or Mode 2 display, press the MIN/MAX key until the display shows the total rainfall value.

To reset the rainfall reading, press the ▲UP ARROW key. The total rainfall amount will be reset to 0, and the time updated to current time.

 **Note:** Until the first rainfall total reset is performed, the time and date of the total rainfall are displayed as "- - -.-.-". After the rainfall total is reset, the rainfall total display will indicate the date and time of the last rainfall total reset.

CARE AND MAINTENANCE:

- Extreme temperatures, vibration and shock should be avoided as these may cause damage to the unit and give inaccurate forecasts and readings.
- Precautions shall be taken when handling the batteries. Injuries, burns, or property damage may be resulted if the batteries are in contact with conducting materials, heat, corrosive materials or explosives. The batteries shall be taken out from the unit before the product is to be stored for a long period of time.
- Immediately remove all low powered batteries to avoid leakage and damage. Replace only with new batteries of the recommended type.
- When cleaning the display and casings, use a soft damp cloth only. Do not use solvents or scouring agents as they may mark the LCD and casings.
- Do not submerge the unit in water.
- Special care shall be taken when handling a damaged LCD display. The liquid crystals can be harmful to user's health.
- Do not make any repair attempts to the unit. Return them to their original point of purchase for repair by a qualified engineer. Opening and tampering with the unit may invalidate their guarantee.
- Never touch the exposed electronic circuit of the device as there is a danger of electric shock should it become exposed.
- Do not expose the units to extreme and sudden temperature changes, this may lead to rapid changes in forecasts and readings and thereby reduce their accuracy.

SPECIFICATIONS:

Indoor Temperature

-40°C to +59.9°C with 0.1°C resolution
-40°F to +139.8°F with 0.2°F resolution
("OF.L" displayed if outside this range)

OUTDOOR TEMPERATURE / DEW POINT

-40°C to +59.9°C with 0.1°C resolution
-40°F to +139.8°F with 0.2°F resolution
("OF.L" displayed if outside this range)

INDOOR HUMIDITY

1% to 99% with 1% resolution
("-" displayed if < 1%, "99" displayed if ≥ 99%)

OUTDOOR HUMIDITY

1% to 99% with 1% resolution
("-" displayed if < 1%, "99" displayed if ≥ 99%)

WIND SPEED/ GUST

0 to 180 km/h with resolution of 0.36 km/h
0 to 111.8 mph with resolution of 0.22 mph
0 to 12 bft
0 to 97.1 knots with resolution of 0.19 knots
0 to 50 m/s with resolution of 0.1 m/s

(displays "OF.L" when > 180 km/h; 111.8 mph; 50 m/s; 12 bft; 97.1 knots)

WIND CHILL/ DEW POINT

-40°C to +59.9°C (-40°F to +140°F)

(displays "OF.L" if outside this)

Relative pressure pre-set range:

920 to 1080 hPa

27.10 to 31.90 inHg

RAINFALL (24H, TOTAL)

0 to 9999.9 mm (0" to 393.7")

(displayed "OF.L" when > 999.9mm)

OUTDOOR DATA RECEPTION

Temperature and humidity data every 13 seconds

Wind data every 17seconds

Rain data every 19 seconds

AIR PRESSURE

Relative pressure pre-set range:

920 to 1080 hpa

27.10 to 31.90 inHg

measured every 15 seconds

TRANSMISSION RANGE

Thermo-hygro: about 100 meters (330 feet) in open space

Rain: about 50 meters (164 feet) in open space

Wind: about 50 meters (164 feet) in open space

POWER CONSUMPTION

Weather Center: 3 x C, IEC LR14, 1.5V

Thermo-hygro transmitter: 2 x C, IEC LR14, 1.5V

Rain sensor: Solar-powered by solar cells

Wind sensor: Solar-powered by solar cells

Battery life: approximately 24 months (Alkaline batteries recommended) for
Weather station and Thermo-hygro

DIMENSIONS (L X W X H)

Weather Center: 222.2 x 34.7 x 163.2mm (8.74" x 1.47" x 6.42")

Thermo-hygro transmitter: 79.4 x 89.8 x 189.3 (3.12" x 3.53" x 7.45")

Wind sensor: 250 x 145.9 x 282.2mm (9.84" x 5.74" x 11.11")

Rain sensor: Ø 131.6 x 182.7mm (Ø 5.19" x 7.19")

USB transceiver: 81.8 x 9 x 22.7mm (3.22" x 0.35" x 0.89")

LIABILITY DISCLAIMER

- The electrical and electronic wastes contain hazardous substances. Disposal of electronic waste in wild country and/or in unauthorized grounds strongly damages the environment.

- Please contact your local or/and regional authorities to retrieve the addresses of legal dumping grounds with selective collection.
- All electronic instruments must from now on be recycled. User shall take an active part in the reuse, recycling and recovery of the electrical and electronic waste.
- The unrestricted disposal of electronic waste may do harm on public health and the quality of environment.
- As stated on the gift box and labeled on the product, reading the “User manual” is highly recommended for the benefit of the user. This product should not be thrown in general rubbish collection points.
- The manufacturer and supplier cannot accept any responsibility for any incorrect readings and any consequences that occur should an inaccurate reading take place.
- This product is designed for use in the home only as indication of the temperature.
- This product is not to be used for medical purposes or for public information.
- The specifications of this product may change without prior notice.
- This product is not a toy. Keep out of the reach of children.
- No part of this manual may be reproduced without written authorization of the manufacturer.



R&TTE Directive 1999/5/EC

Summary of the Declaration of Conformity : We hereby declare that this wireless transmission device does comply with the essential requirements of R&TTE Directive 1999/5/EC.